

7610 7615 – BANK









licht &  
meubels

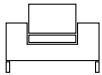
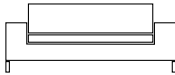
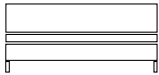

GELDERLAND

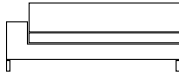

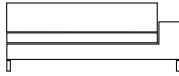
---



Afmetingen & Specificaties

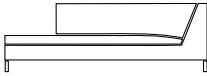
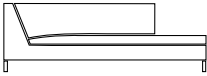

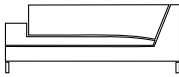
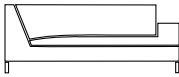
							
	fauteuil 7610 F 2A	2,5-zits bank 7610 B25 2A	3-zits bank 7610 B3 2A	2,5-zits bank zonder armen 7610 B25 ZA	3-zits bank zonder armen 7610 B3 ZA	poef 7619 P	poef 7618 P
AFMETINGEN	110 x 85 x 81 ZH 45 ZD 55	202 x 85 x 81 ZH 45 ZD 55	232 x 85 x 81 ZH 45 ZD 55	150 x 85 x 81 ZH 45 ZD 55	180 x 85 x 81 ZH 45 ZD 55	85 x 85 x 45	85 x 46 x 45

				
	2,5-zits bank arm links 7610 B25 AL	3-zits bank bank arm links 7610 B3 AL	2,5-zits bank bank arm rechts 7610 B25 AR	3-zits bank bank arm rechts 7610 B3 AR
AFMETINGEN	176 x 85 x 81 ZH 45 ZD 55	206 x 85 x 81 ZH 45 ZD 55	176 x 85 x 81 ZH 45 ZD 55	206 x 85 x 81 ZH 45 ZD 55

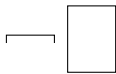
				
	chaise longue arm links 7610 CL AL	chaise longue arm rechts 7610 CL AR	chaise longue XL arm links 7619 CL AL	chaise longue XL arm rechts 7620 CL AR
AFMETINGEN	88 x 148 x 81 ZH 45	88 x 148 x 81 ZH 45	89 x 240 x 81 ZH 45 ZD 59	89 x 240 x 81 ZH 45 ZD 59

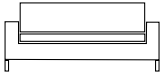
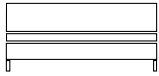

			
	bank arm links en hoekarm rechts 7610 HL AL	bank arm rechts en hoekarm links 7610 HR AR	hoekelement 7613 H
AFMETINGEN	226 x 85 x 81 ZH 45 ZD 55	226 x 85 x 81 ZH 45 ZD 55	85 x 85 x 81 ZH 45 ZD 55

	 armblad M06511.600	 armblad met leetuurhouder M07880
AFMETINGEN	47,5 x 26,5 x 4	25 x 40 x 21
MATERIAAL	metaal	metaal
KLEUR	off black RAL 000300	off black RAL 000300
	zijdegrijs RAL 7044	zijdegrijs RAL 7044

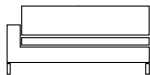
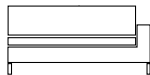
							
	fauteuil 7615 F 2A	2,5 zits bank 7615 B25 2A	3-zits bank 7615 B3 2A	bank zonder armen 7615 B25 ZA	bank zonder armen 7615 B3 ZA	poef 7619 P	poef 7618 P
AFMETINGEN	92 x 85 x 81 ZH 45 ZD 55	182 x 85 x 81 ZH 45 ZD 55	212 x 85 x 81 ZH 45 ZD 55	150 x 85 x 81 ZH 45 ZD 55	180 x 85 x 81 ZH 45 ZD 55	87 x 85 x 45	83 x 46 x 45

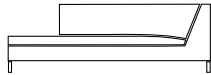
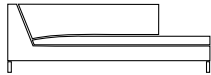
				
	2,5-zits bank arm links 7615 B25 AL	3-zitsbank arm links 7615 B3 AL	2,5-zits bank arm rechts 7615 B25 AR	3-zits bank arm rechts 7615 B3 AR
AFMETINGEN	165 x 85 x 81 ZH 45 ZD 55	195 x 85 x 81 ZH 45 ZD 55	165 x 85 x 81 ZH 45 ZD 55	195 x 85 x 81 ZH 45 ZD 55

		
	chaise longue XL arm links 7619 CL AL	chaise longue XL arm rechts 7620 CL AR
AFMETINGEN	240 x 89 x 81 ZH 45 ZD 59	240 x 89 x 81 ZH 45 ZD 59

			
	bank arm links en hoekarm rechts 7615 HL AL	bank met arm rechts en hoekarm links 7615 HR AR	hoekelement 7613 H
AFMETINGEN	215 x 85 x 81 ZH 45 ZD 55	215 x 85 x 81 ZH 45 ZD 55	85 x 85 x 81 ZH 45 ZD 55

## 7610

### Jan des Bouvrie

Het kussen in de zitting van de 7610 is los gestoffeerd van de romp, maar is wel vast verbonden met de hoes. Hierdoor oogt de bank minder strak dan de verder identieke 6511 bank, maar blijft het kussen wel op zijn plek. De 7610 heeft bovendien een iets zachter zitcomfort. Beide series zijn te combineren en compleet gelijk in mogelijkheden. De metalen poot is leverbaar in diverse kleuren.

The cushion in the 7610's seat is upholstered separately from the body, but is firmly attached to the cover. As a result, the sofa looks less tight than the otherwise identical 6511 sofa, but the cushion remains the same. The 7610 also has a slightly softer seating comfort. Both series can be combined and offer equal possibilities. The metal leg is available in various colours.









Gelderland | Quality



In alle Gelderland producten worden hoogwaardige materialen gebruikt. De romp wordt vervaardigd van massief beukenhout of metaal; u krijgt hierop een garantie van 20 jaar\*. Gelderland banken en fauteuils worden gestoffeerd met een ingenieus in eigen huis ontwikkeld hoezen systeem. De stof wordt met strips aan de romp bevestigd waardoor de bekleding kan worden gereinigd of gewisseld. Zo verandert het meubel in loop der jaren met zijn eigenaars mee. Wij krijgen regelmatig modellen van tientallen jaren oud aangeboden voor een complete renovatie. Een groter compliment voor duurzaam design is haast niet denkbaar.

All Gelderland products are made of high-quality materials. The hull is made of solid beech wood or metal; this comes with a 20-year guarantee\*. Gelderland sofas and armchairs are upholstered with an ingenious in-house developed cover system. The fabric is attached to the hull with strips so that the upholstery can be cleaned or changed. In this way, the furniture changes with its owners over the years. We regularly get back models that are decades old for a complete renovation. A greater compliment for sustainable design is hardly conceivable.



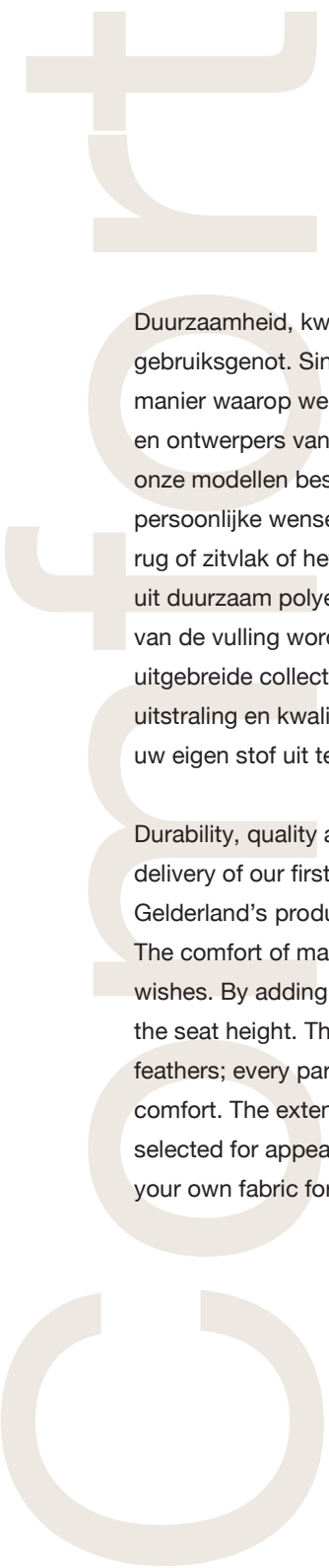



Duurzaamheid, kwaliteit en comfort vormen de basis voor jarenlang gebruiksgenot. Sinds de aflevering van ons eerste meubel in 1936 is de manier waarop we wonen ingrijpend veranderd. De productontwikkelaars en ontwerpers van Gelderland weten dat als geen ander. Bij veel van onze modellen bestaat de mogelijkheid het comfort aan te passen aan uw persoonlijke wensen. Door de toevoeging van een zachter dek of kussen in rug of zitvlak of het aanpassen van de zithoogte. De vulling wordt opgebouwd uit duurzaam polyether, koudschuim of schachtloze veren; elk onderdeel van de vulling wordt zorgvuldig geselecteerd voor optimaal zitcomfort. De uitgebreide collectie meubelstoffen en leder wordt met zorg geselecteerd op uitstraling en kwaliteit. Daarnaast is het bij de meeste meubels mogelijk om uw eigen stof uit te zoeken en in te zenden.

Durability, quality and comfort form the basis for years of enjoyment. Since the delivery of our first furniture in 1936, the way we live has changed dramatically. Gelderland's product developers and designers are aware of this like no other. The comfort of many of our models can be adjusted to your own personal wishes. By adding a softer top or cushion in the back or seat, or by adjusting the seat height. The stuffing is made of durable polyether, cold foam or natural feathers; every part of the stuffing is carefully selected for optimal seating comfort. The extensive collection of upholstery fabrics and leather is carefully selected for appearance and quality. It is also possible to choose and submit your own fabric for most furniture.

licht &  
meubels

G

 [gelderlanddesign](#)

 [gelderlanddesign](#)